

## AtriClip PRO® LAA Exclusion System

### INSTRUCTIONS FOR USE

# PRO135, PRO140, PRO145, PRO150

MD

⚠ **CAUTION:** Federal law (US) restricts this device to sale by or on the order of a physician.

FIGURE 1

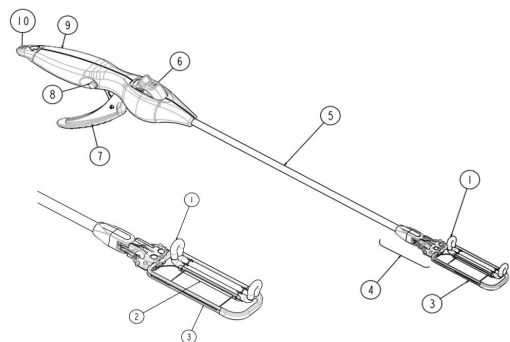

FIGURE 2

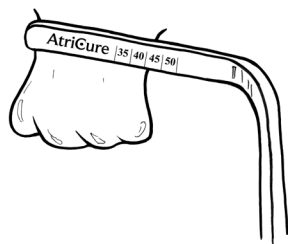

FIGURE 4

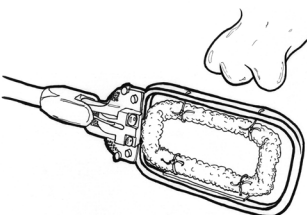

FIGURE 3

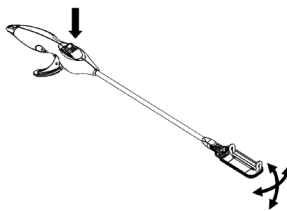

FIGURE 5

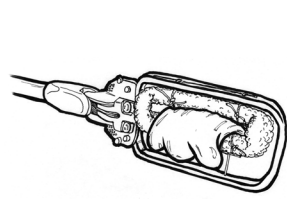

FIGURE 6

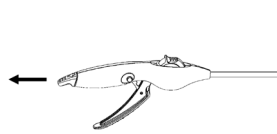
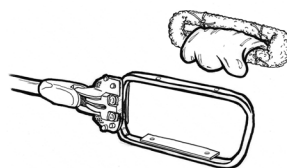

FIGURE 7



### INSTRUCTIONS FOR USE

en

#### AtriClip PRO® LAA Exclusion System

#### INDICATION FOR USE

The AtriClip LAA Exclusion System is indicated for the exclusion of the heart's left atrial appendage, performed under direct visualization and in conjunction with other cardiac surgical procedures.

Direct visualization, in this context, requires that the surgeon is able to see the heart directly, with or without assistance from a camera, endoscope, etc., or other appropriate viewing technologies.

#### CONTRAINDICATIONS

1. Do not use this device as a contraceptive tubal occlusion device.
2. Do not use this device if the patient has a known allergy to Nitinol (nickel titanium alloy).
3. Do not use this device if evidence of systemic infection, bacterial endocarditis, or in presence of infected operating field.

#### SYSTEM DESCRIPTION

The AtriClip LAA Exclusion System contains the AtriClip (Clip) for exclusion of the heart's left atrial appendage (LAA). Preclinical animal studies (Kamohara 2005,2006) demonstrate that complete exclusion with the Clip also results in acute and chronic electrical isolation of the LAA. A human clinical study (Starck 2012) has demonstrated acute electrical isolation. Chronic electrical isolation has not been evaluated in human clinical studies.

The AtriClip LAA Exclusion System is a delivery and deployment device preloaded with an AtriClip. The Clip is pre-loaded on a disposable Clip applicator. The AtriClip is a permanent implant; device lifetime is equal to patient lifetime. The Clip was determined to be "MR Conditional" per the requirements of standard ASTM F2503-23e1.

The AtriClip LAA Exclusion System is used to deliver a preloaded clip to the target LAA site. The Clip is a sterile, permanent implant composed of Grade 2 Titanium and Polyurethane beams, Nitinol springs, and covered in a knit-braided Polyethylene Terephthalate fabric that contains a small fraction of titanium dioxide. The AtriClip LAA Exclusion System with preloaded AtriClip is not made with natural rubber latex and does not contain phthalates. Detailed materials information for implanted Clip sizes 35 mm to 50 mm are below:

Material	Mass (g)	CAS #
Titanium Grade 2	0.51 to 0.72	7440-32-6
Polyurethane	0.52 to 0.68	9009-54-5
Nitinol	0.27 to 0.39	Nickel, 7440-02-0 Titanium, 7440-32-6
Polyethylene Terephthalate	0.35 to 0.39	25038-59-9
Titanium Dioxide	0.001 to 0.002	13463-67-7

#### ENVIRONMENTAL SPECIFICATIONS

Storage	Transit
Temperature: -29°C/ -20°F to 60°C/ 140°F	Temperature: -29°C/ -20°F to 60°C/ 140°F
Relative Humidity: 15% to 85%	Relative Humidity: 30% to 85%
Atmospheric Pressure: N/A	Atmospheric Pressure: N/A

#### PACKAGE CONTENTS

1. One (1) AtriClip LAA Exclusion System
2. One (1) Implant Card and (1) Implant Card Leaflet

The AtriClip LAA Exclusion System is supplied STERILE and NON-PYROGENIC in an unopened, undamaged package. For single use only. Do not re-sterilize. Do not re-use.

#### SYSTEM ACCESSORIES

Other devices, not included with the System, may be used in conjunction with the AtriClip LAA Exclusion System. These may include but are not limited to the following:

- Selection Guide (CGG100) (Guide)—Packaged Separately

#### ATRICLIP LAA EXCLUSION SYSTEM

#### NOMENCLATURE (SEE FIGURE 1)

[1] AtriClip	[6] Articulation Release Button
[2] Clip Pull Bar	[7] Activation Lever
[3] Deployment Loop	[8] Lever Release Button
[4] Articulation Joints	[9] Handle
[5] Shaft	[10] Deployment Tab

#### ⚠ WARNINGS ⚠

Read all instructions carefully for the AtriClip LAA Exclusion System before use and use the device only as intended. Use of the AtriClip LAA Exclusion System should be limited to properly trained and qualified medical personnel. Improper use of this system may lead to device malfunction, failure to provide intended therapy, and/or serious injury to user or patient.

Do not use on tissue which, in the opinion of the surgeon, would not be able to tolerate conventional suture materials or conventional closure techniques (such as surgical stapling). Doing so may result in: tissue trauma, dehiscence, tissue tearing, displacement and/or lack of desired hemostasis.

AtriClip placement that allows blood flow into the LAA may not result in complete exclusion and/or electrical isolation.

DO NOT RESTERILIZE. The AtriClip LAA Exclusion System is provided STERILE and is intended for SINGLE use only. Re-sterilization may cause loss of function or injury to patient.

Evaluate if thrombus is present in LAA. Management of thrombus is dependent on surgeon's standard of care. It is not recommended to place Clip on LAA if there is evidence of thrombus in LAA. Doing so may result in serious patient injury.

Do not use the Clip in temperatures below 20°C (68°F). Application of Clip in temperatures below 20°C (68°F) may affect device performance and result in incomplete exclusion of the structure.

The safety and effectiveness of this device in atrial rhythm control management, either alone or in combination with ablative treatment, has not been established.

#### ⚠ WARNING ⚠

This device contains small amounts of Nickel (CAS# 7440-02-0) and Cobalt (CAS# 7440-48-4). Do not use this device if the patient has sensitivity to Nickel or Cobalt as this may result in an adverse patient reaction.

#### COMPLICATIONS

Potential complications associated with the use of the AtriClip PRO1 LAA Exclusion System and procedure include, but are not limited to, those listed below:

- Air embolism
- Allergic reaction to anesthesia, anticoagulant, implant material
- Anaphylactic shock
- Anesthesia risks
- Aneurysm
- Angina
- Arrhythmia needing medical treatment (new onset)
- Arterial or venous dissection and/or perforation
- Arterial rupture
- Arterial spasm
- Arteriovenous fistula
- Extension of cardiopulmonary/extracorporeal bypass
- Fever
- Gastric motility disorders
- Gastro-intestinal bleed
- Hematoma
- Hematuria
- Hemothorax
- Hypertension
- Hypotension
- Iatrogenic atrial flutter
- Iatrogenic lung injury (e.g., chest tube placement)
- Ischemia

- Atelectasis (major lung collapse with significant symptoms such as cyanosis, extreme shortness of breath, dyspnea, and/or stabbing pain on the affected side)
- Atrial rupture
- Atrio-esophageal fistula
- AV block requiring permanent pacemaker (new onset)
- Bleeding requiring intervention
- Blood vessel damage
- Cardiac perforation
- Cardiac tamponade
- Cardiac valve injury
- Cerebrovascular accident (CVA)/ Transient Ischemic Attack (TIA)/stroke (ischemic or hemorrhagic)
- Chest pain/discomfort
- Compression of coronary artery
- Conduction disturbances
- Congestive heart failure (new onset or exacerbation)
- Coronary artery injury
- Death
- Device breakage/inability to remove
- Device-related death
- Diaphragmatic paralysis (unilateral or bilateral)
- Drug reaction (significant reaction to any procedure related medications requiring treatment, including allergic reaction and anaphylactic shock)
- Emergency during procedure requiring a change in planned access
- Empyema
- Endocarditis (bacterial)
- Esophageal injury
- Esophageal rupture
- Kinking of coronary artery
- LAA dehiscence
- LAA tears
- Left atrial embolism
- Myocardial infarction (MI)
- Nerve injury (phrenic, laryngeal, thoracic, etc.)
- Pain/discomfort
- Pericardial effusion
- Pericarditis
- Permanent pacemaker
- Persistent chest pain (post discharge surgical incision pain, not angina)
- Phrenic nerve paralysis
- Pleural effusion
- Pneumonia
- Pneumothorax
- Postoperative embolic complications
- Pseudoaneurysm
- Pulmonary edema
- Pulmonary embolism
- Renal insufficiency or failure
- Respiratory distress or failure (breathing problems)
- Sepsis
- Stenosis of left circumflex artery
- Sterility-related infection
- Superficial wound infection
- Surgical site infection
- Systemic adverse reaction due to device corrosion
- Thrombus and/or thromboembolism (including deep vein thrombosis)
- Tissue injury
- Tissue perforation
- Tracheal esophageal trauma
- Vascular access complications

#### INSTRUCTIONS FOR USE

Surgeon judgment, with the assistance of the Guide, should determine what size Clip to apply.

This IFU is designed to assist in using this product. It is not a reference to surgical techniques.

#### CLIP SELECTION

#### ⚠ WARNING ⚠

Carefully consider any presurgical treatment the patient may have undergone when selecting Clip size. Preoperative radiotherapy may result in changes to tissue. These changes may, for example, cause the tissue thickness to exceed the indicated range for the selected Clip size. Failure to correctly size the Clip may result in: tissue trauma, dehiscence, tissue tearing, displacement, lack of desired hemostasis, and/or incomplete exclusion of the structure.

1. Using the Guide, determine correct selection of the LAA Clip (See Figure 2). Clip sizes are located on the device package.

Labeled Clip Size	LAA Size Range
35 mm	29 – 35 mm (1.14 – 1.38 in)
40 mm	34 – 40 mm (1.34 – 1.57 in)
45 mm	39 – 45 mm (1.54 – 1.77 in)
50 mm	44 – 50 mm (1.73 – 1.97 in)

## ⚠️ WARNINGS ⚠️

Do not use on a LAA less than 29 mm (1.14 in) in width and 1 mm (0.04 in) wall thickness. Doing so may result in: tissue trauma, dehiscence, tissue tearing, displacement, and/or lack of desired hemostasis.

Do not use on a LAA greater than 50 mm (1.97 in) when tissue is uncompressed. Doing so may result in incomplete exclusion of the structure.

- Using sterile technique, remove the AtriClip LAA Exclusion System from its packaging.

## ⚠️ WARNING ⚠️

If the sterile package is damaged and/or the sterile barrier is breached, discard device and DO NOT USE to avoid the risk of patient infection.

⚠️ **CAUTION:** Do not drop the device as this may induce damage to the device. If the device is dropped, do not use. Replace with a new device.

- Using the Activation Lever on the handle, gently open and close the Clip to assure proper function.

## ⚠️ WARNING ⚠️

Do not open and close the Clip more than 3 times with the Activation Lever prior to deployment. This may lead to incomplete exclusion of the structure.

- By pressing the Articulation Release Button and pulling it backwards (proximal) into the unlocked position, the Deployment Loop of the AtriClip LAA Exclusion System may be manually articulated up and down and side-to-side from 0° (inline - as supplied) to ±30° relative to the shaft to aid in the proper placement of the AtriClip to take into account anatomical variations in the patient's anatomy (See Figure 3).
- To lock the End Effector in position, disengage the Articulation Release Button by pushing down, forward and then releasing.

⚠️ **CAUTION:** Do not attempt to articulate the Deployment Loop while in the locked position. Force applied while in the locked position may cause damage to the device.

## CLIP POSITIONING

## ⚠️ WARNING ⚠️

Position and deploy Clip in a manner that provides direct visualization of all tissues being accessed. Direct visualization, in this context, requires that the surgeon is able to see the heart directly, with or without assistance from a camera, endoscope, etc., or other appropriate viewing technologies. Poor visualization may result in suboptimal placement and damage or obstruction of surrounding structures.

⚠️ **CAUTION:** Do not kink or bend the Shaft as this may affect device performance.

- Maneuver the AtriClip LAA Exclusion System into the targeted dissection plane.
- Gently open the Clip by squeezing the Activation Lever.

**NOTE:** The Clip can be locked in the open position by means of a locking feature in the Handle of the device. The lock will engage when the Activation Lever is activated and can be disengaged by gently pressing the Lever Release Button.

- Orient the Clip applicator with preloaded Clip at the tip of the LAA. Ensure the loops at the ends of the Clip are pointed away from the LAA (See Figure 4).
- Gently position the Clip at the base of the LAA (See Figure 5).
- Position the Clip in a manner that provides clear visualization of all tissues being accessed.
- While the Clip is still affixed to the Deployment Device, ensure that no surrounding structures interfere with or are damaged by the Clip, and that the Clip is placed correctly.
- If the Clip is not placed correctly, gently open the Clip and reposition as needed.

## DEPLOYMENT

### ⚠️ WARNINGS ⚠️

Carefully evaluate Clip position, tissue thickness, and tissue width prior to Clip deployment. To determine appropriate Clip size, refer to the Guide Instructions for Use. Failure to correctly size or deploy the Clip may result in: tissue trauma, dehiscence, tissue tearing, displacement, and/or lack of desired hemostasis.

Unless medically necessary, do not attempt to reposition or remove the Clip after deployment. This may result in tissue damage or tearing.

- After the Clip is positioned correctly, grasp the Activation Lever and depress the Lever Release Button. Slowly release the Activation Lever, allowing the Clip to close.
- Deploy the Clip by slowly pulling the Deployment Tab at the proximal end of the Handle.

**NOTE:** The Deployment Tab with steel cables may be completely removed from the end of the Handle (See Figure 6).

⚠️ **CAUTION:** Take care to minimize manipulation of the LAA and Clip after Clip deployment.

- Following Clip deployment carefully squeeze the Activation Lever to retract the Clip Pull Bar against the Deployment Loop of the Clip applicator to prevent unintentional tissue snags when removing the Deployment Loop.
- Carefully remove the Deployment Loop from the LAA leaving the Clip and attachment suture behind (See Figure 7).

**NOTE:** After pulling the Deployment Tab, the AtriClip LAA Exclusion System cannot be used to reposition or remove the Clip.

## DISPOSAL INFORMATION

After use, this device should be treated as medical waste and disposed of following hospital protocol.

## SERIOUS INCIDENT

Any serious incident that has occurred in relation to this device should be reported to AtriCure.

## RETURN OF USED PRODUCT

If, for any reason, this product must be returned to AtriCure, Inc., a return goods authorization (RGA) number is required from AtriCure, Inc., prior to shipping.

If the product has been in contact with blood or body fluids, it must be thoroughly cleaned and disinfected before packing. It should be shipped in either the original carton or an equivalent carton, to prevent damage during shipment; and it should be properly labeled with an RGA number and an indication of the biohazardous nature of the contents of shipment.

Instructions for cleaning and materials, including appropriate shipping containers, proper labeling, and an RGA number may be obtained from AtriCure, Inc.

## DISCLAIMER STATEMENTS

Users assume responsibility for approving the acceptable condition of this product before it is used, and for ensuring that the product is only used in the manner described in these instructions for use, including, but not limited to, ensuring that the product is not re-used.

Under no circumstances will AtriCure, Inc. be responsible for any incidental, special or consequential loss, damage, or expense, which is the result of the deliberate misuse or re-use of this product, including any loss, damage, or expense which is related to personal injury or damage to property.

## HANDLING INFORMATION: AtriClip

## MRI SAFETY INFORMATION



The AtriClip is MR Conditional. A patient with the AtriClip may be safely scanned under the following conditions. Failure to follow these conditions may result in injury to the patient:

- Nominal Values of Static Magnetic Field:** 1.5-Tesla or 3.0-Tesla
- Maximum Spatial Field Gradient:** 40-T/m (4,000-gauss/cm)
- Type of RF Excitation:** Circularly Polarized (CP) (i.e., Quadrature Transmission)
- Transmit RF Coil Information:** There are no transmit RF coil restrictions
- Operating Mode of MR System:** Normal Operating Mode
- Maximum Whole Body Averaged SAR:** 2-W/kg (Normal Operating Mode)
- Limits on Scan Duration:** Whole body averaged SAR of 2-W/kg for 60 minutes of continuous RF exposure (i.e., per pulse sequence or back-to-back sequences/series without breaks)
- MR Image Artifact:** The presence of this implant produces an imaging artifact. Therefore, carefully select pulse sequence parameters if the implant is located in the area of interest

## SYMBOLS GLOSSARY

Refer to the outer package label to see which symbols apply to this product.

	Single sterile barrier system with protective packaging outside		Single sterile barrier system with protective packaging inside
	Manufacturer		Caution
	Does not contain phthalates		Contains hazardous substances
	Do not use if package is damaged		Non-pyrogenic
	Sterilized using irradiation		Consult Instructions For Use
	Do not re-use		Do not re-sterilize
	Not Made with natural Rubber Latex		Catalogue Number
	Model Number		Unique Device Identifier
	Lot Number		Use-by date
	Prescription Use Only		MR Conditional
	Country of Manufacture		Medical Device
	Keep dry	 Transit Humidity limit	
 Transit Temperature limit			

## REFERENCES

- Kamohara K, et al. A novel device for left atrial appendage exclusion. J Thorac Cardiovasc Surg 2005
- Kamohara K, Fukamachi et al. Evaluation of a novel device for left atrial appendage exclusion: the second-generation atrial exclusion device. J Thorac Cardiovasc Surg 2006
- Starck C, et al. Epicardial left atrial appendage clip occlusion also provides the electrical isolation of the left atrial appendage. Interactive CardioVascular and Thoracic Surgery 15 (2012)



AtriCure Inc.  
7555 Innovation Way  
Mason, Ohio 45040 USA  
+1 866 349 2342  
+1 513 755 4100